

6 5 4 3 2 1

D

D

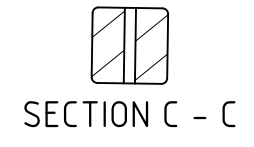
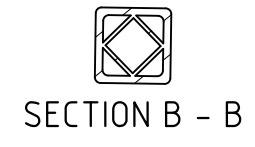
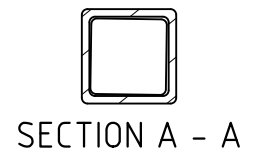
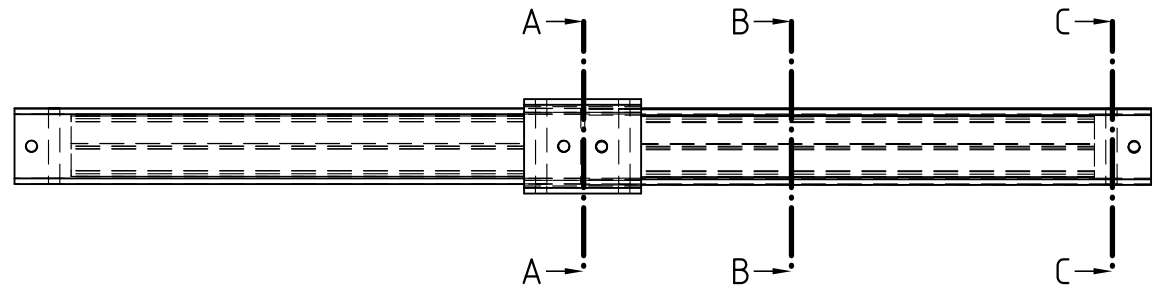
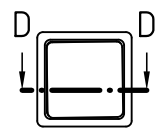

C

C

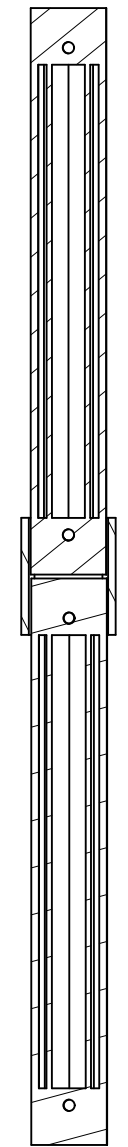

SECTION D - D

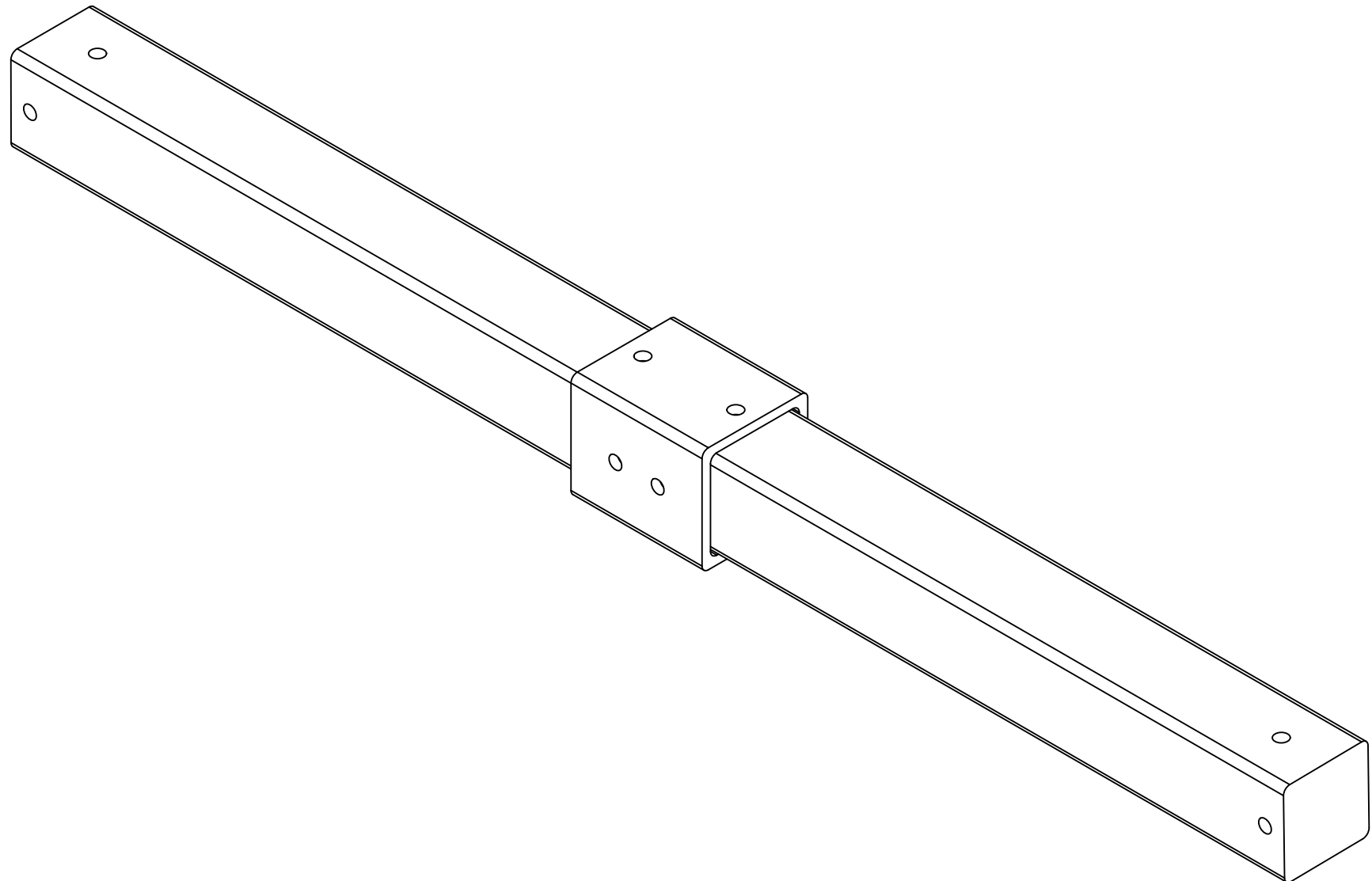

B

B

A

A

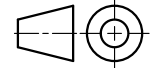
UNLESS OTHERWISE SPECIFIED: DIMENSIONS ARE IN MM ANGULAR $\angle = \pm^\circ$ FRACTIONAL = \pm SURFACE FINISH $\sqrt{\quad}$ DO NOT SCALE DRAWING BREAK ALL SHARP EDGES AND REMOVE BURRS FIRST ANGLE PROJECTION 	NAME	SIGNATURE	DATE	TITLE
	DRAWN			
	CHECKED			
	APPROVED			
MATERIAL	FINISH	SIZE A3	DWG NO.	REV.
		SCALE	WEIGHT	SHEET

6 5 4 3 2 1