

H21LTB

H21LTI

H21LOB

H21LOI

PACKAGE DIMENSIONS

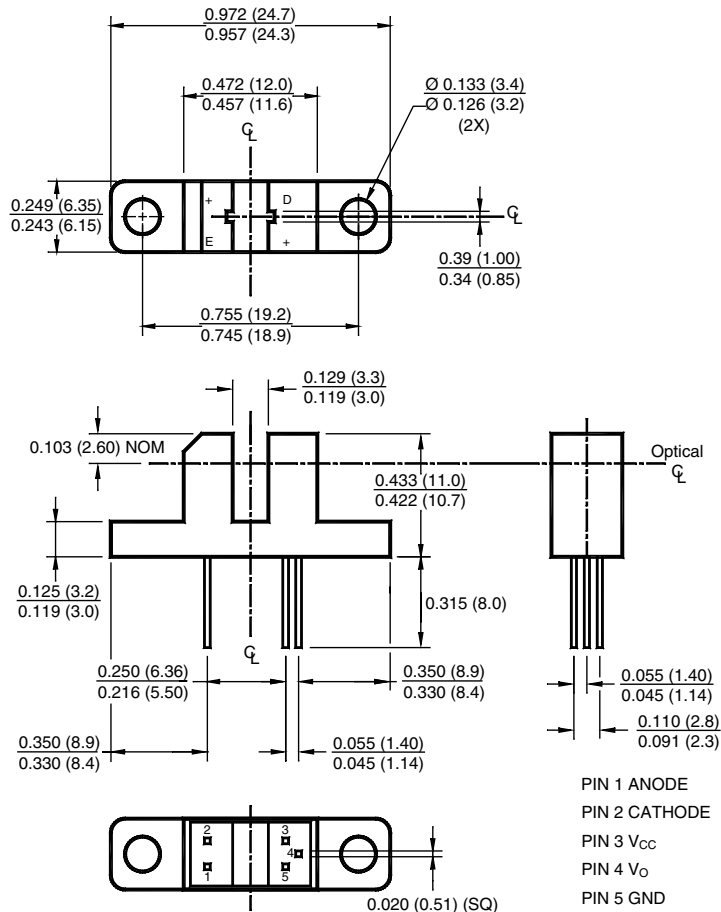

NOTES:

1. Dimensions for all drawings are in inches (mm).
2. Tolerance of ± .010 (.25) on all non-nominal dimensions unless otherwise specified.

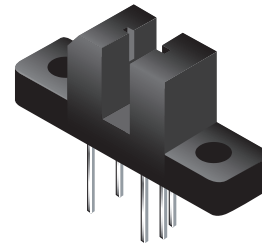

Features

- Low cost
- 0.035" apertures
- Black plastic opaque housing
- Mounting tabs on housing
- Choice of inverter or buffer output functions
- Choice of open-collector or totem-pole output configuration
- TTL/CMOS compatible output functions

Description

The H21L series are slotted optical switches designed for multipurpose non contact sensing. They consist of a GaAs LED and a silicon OPTOLOGIC® sensor packaged in an injection molded housing and facing each other across a .124" (3.15 mm) gap. The output is either inverting or non-inverting, with a choice of totem-pole or open-collector configuration for TTL/CMOS compatibility

H21LTB

H21LTI

H21LOB

H21LOI

Part Number Definitions

H21LTB	Totem-pole, buffer output
H21LTI	Totem-pole, inverter output
H21LOB	Open-collector, buffer output
H21LOI	Open-collector, inverter output

Input/Output Table

Part Number	LED	Output
H21LTB	On	High
H21LTB	Off	Low
H21LTI	On	Low
H21LTI	Off	High
H21LOB	On	High
H21LOB	Off	Low
H21LOI	On	Low
H21LOI	Off	High

H21LTB

H21LTI

H21LOB

H21LOI

Schematics

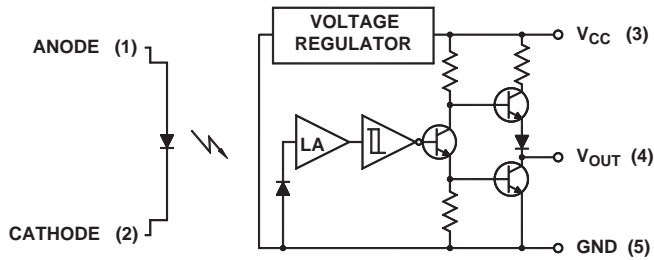

H21LTB

Totem-Pole Output Buffer

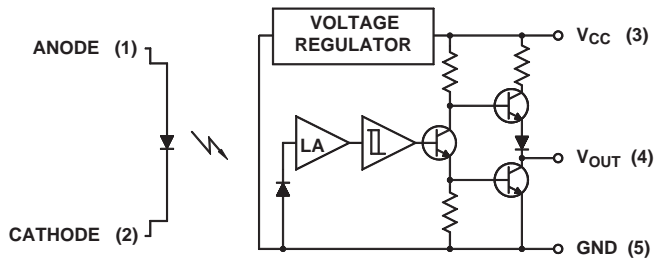

H21LTI

Totem-Pole Output inverter

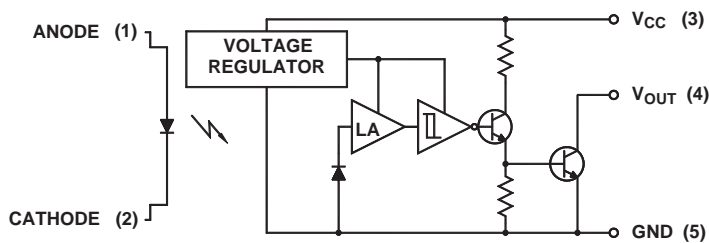

H21LOB

Open-Collector Output Buffer

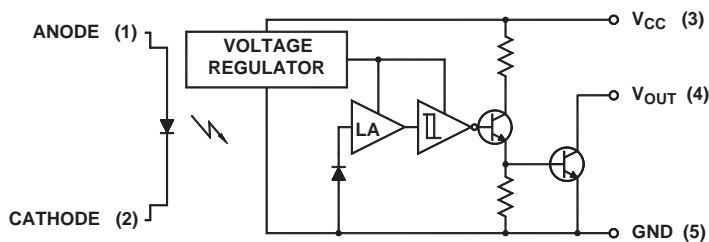

H21LOI

Open-Collector Output Inverter

H21LTB

H21LTI

H21LOB

H21LOI

Absolute Maximum Ratings ($T_A = 25^\circ\text{C}$ unless otherwise specified)			
Parameter	Symbol	Rating	Units
Operating Temperature	T_{OPR}	-40 to +85	$^\circ\text{C}$
Storage Temperature	T_{STG}	-40 to +85	$^\circ\text{C}$
Soldering Temperature (Iron) ^(3,4,5,6)	T_{SOL-I}	240 for 5 sec	$^\circ\text{C}$
Soldering Temperature (Flow) ^(3,4,6)	T_{SOL-F}	260 for 10 sec	$^\circ\text{C}$
Input (Emitter)			
Continuous Forward Current	I_F	50	mA
Reverse Voltage	V_R	6	V
Power Dissipation ⁽¹⁾	P_D	100	mW
Output (Sensor)			
Output Current	I_O	50	mA
Supply Voltage	V_{CC}	4.0 to 16	V
Output Voltage	V_O	30	V
Power Dissipation ⁽²⁾	P_D	150	mW

H21LTB

H21LTI

H21LOB

H21LOI

Electrical/Optical Characteristics (T _A = 25°C)						
Parameter	Test Conditions	Symbol	Min.	Typ	Max.	Units
Input (Emitter)						
Forward Voltage	I _F = 20 mA	V _F	—		1.5	V
Reverse Leakage Current	V _R = 5 V	I _R	—		10	μA
Output (Sensor)						
Supply Current	V _{CC} = 5 V	I _{CC}	—		5	mA
Coupled						
Low Level Output Voltage H21LTB, H21LOB	I _F = 0 mA, V _{CC} = 5 V, R _L = 100 Ω	V _{OL}	—		0.4	V
Low Level Output Voltage H21LTI, H21LOI	I _F = 15 mA, V _{CC} = 5 V, R _L = 360 Ω	V _{OL}	—		0.4	V
High Level Output Voltage H21LTB	I _F = 15 mA, V _{CC} = 5 V, I _{OH} = -800 μA	V _{OH}	2.4		—	V
High Level Output Voltage H21LTI	I _F = 0 mA, V _{CC} = 5 V, I _{OH} = -800 μA	V _{OH}	2.4		—	V
High Level Output Current H21LOB	I _F = 0 mA, V _{CC} = 5 V, I _{OH} = -800 μA	I _{OH}			100	μA
High Level Output Current H21LOI	I _F = 0 mA, V _{CC} = 5 V, V _{OH} = 30 V	I _{OH}	—		100	μA
Turn on Threshold Current	V _{CC} = 5 V, R _L = 360 Ω	I _F (+)	—		15	mA
Turn off Threshold Current	V _{CC} = 5 V, R _L = 360 Ω	I _F (-)	0.50		—	mA
Hysteresis Ratio		I _F (+) / I _F (-)		1.2		
Propagation Delay	V _{CC} = 5 V, R _L = 360 Ω (See Fig. 9)	t _{PLH} , t _{PHL}		5		μs
Output Rise and Fall Time	V _{CC} = 5 V, R _L = 360 Ω (See Fig. 9)	t _r , t _f		70		ns

Notes: (Applies to Max Ratings and Characteristics Tables.)

1. Derate power dissipation linearly 1.67 mW/°C above 25°C.
2. Derate power dissipation linearly 2.50 mW/°C above 25°C.
3. RMA flux is recommended.
4. Methanol or isopropyl alcohols are recommended as cleaning agents.
5. Soldering iron 1/16" (1.6mm) from housing.
6. As long as leads are not under any stress or spring tension.

H21LTB

H21LTI

H21LOB

H21LOI

Figure 1. Output Voltage vs. Input Current (Inverters)

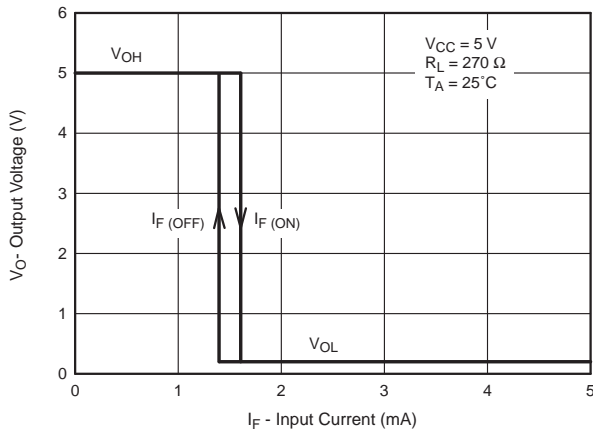

Figure 2. Output Voltage vs. Input Current (Buffers)

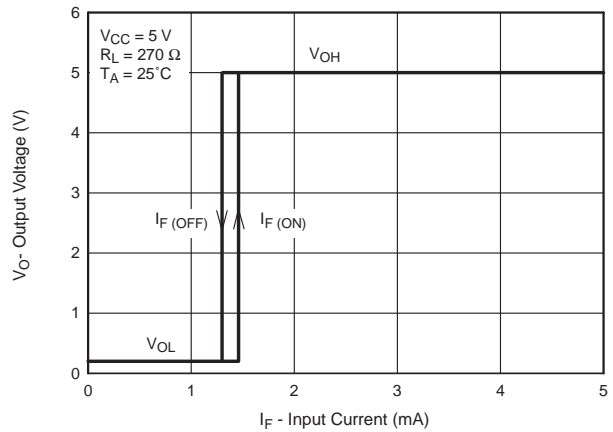

Figure 3. Normalized Threshold Current vs. Shield Distance

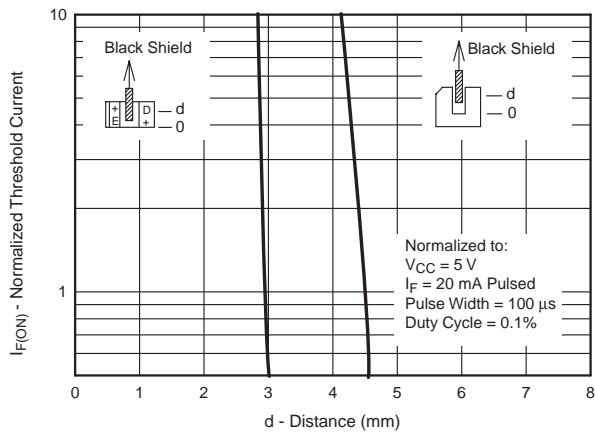
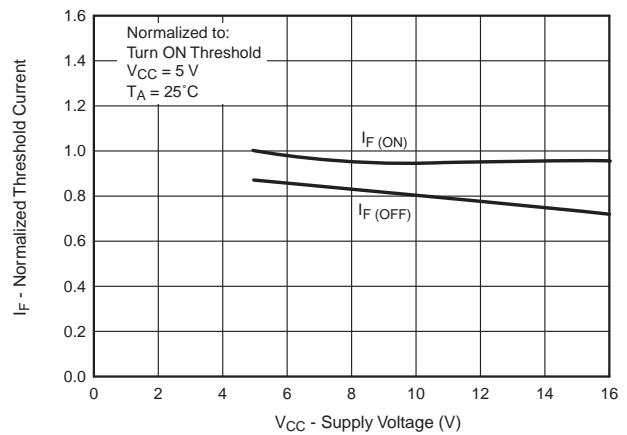

Figure 4. Normalized Threshold Current vs. Supply Voltage



H21LTB

H21LTI

H21LOB

H21LOI

Figure 5. Normalized Threshold Current vs. Ambient Temperature

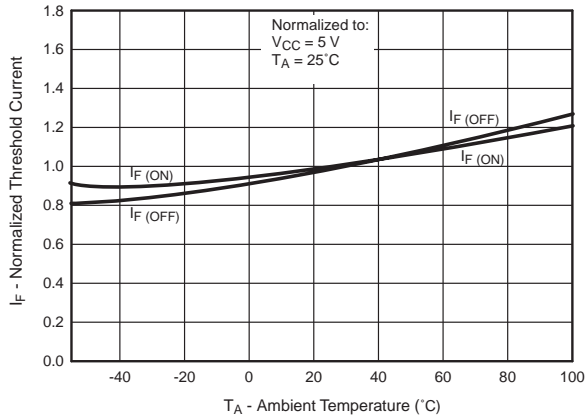

Figure 6. Forward Current vs. Forward Voltage

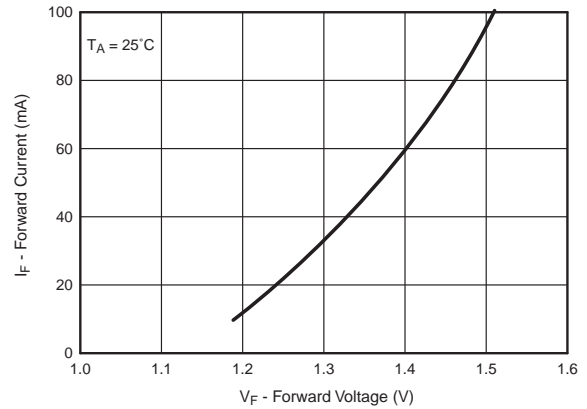

Figure 7. Low Output Voltage vs. Output Current

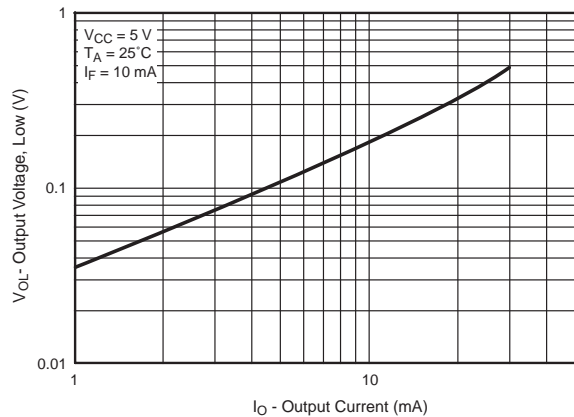
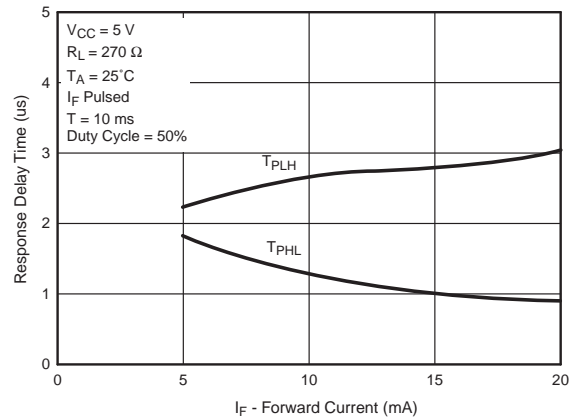

Figure 8. Response Time vs. Forward Current



H21LTB

H21LTI

H21LOB

H21LOI

Figure 9. Switching Speed Test Circuit

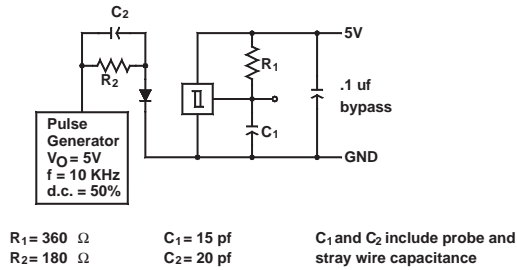

Figure 10. Typical Operating Circuit

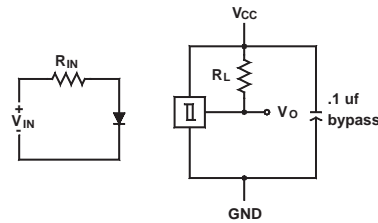

Figure 11. Switching Times Definition for Buffers

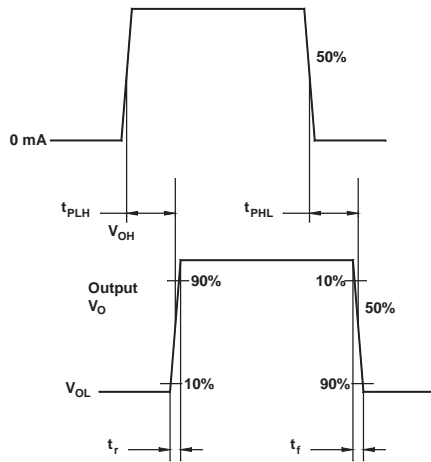
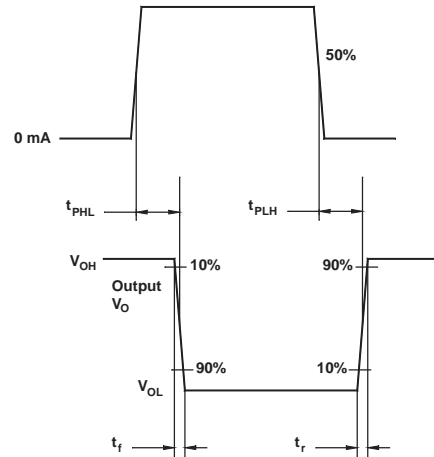

Figure 12. Switching Times Definition for Inverters



H21LTB

H21LTI

H21LOB

H21LOI

DISCLAIMER

FAIRCHILD SEMICONDUCTOR RESERVES THE RIGHT TO MAKE CHANGES WITHOUT FURTHER NOTICE TO ANY PRODUCTS HEREIN TO IMPROVE RELIABILITY, FUNCTION OR DESIGN. FAIRCHILD DOES NOT ASSUME ANY LIABILITY ARISING OUT OF THE APPLICATION OR USE OF ANY PRODUCT OR CIRCUIT DESCRIBED HEREIN; NEITHER DOES IT CONVEY ANY LICENSE UNDER ITS PATENT RIGHTS, NOR THE RIGHTS OF OTHERS.

LIFE SUPPORT POLICY

FAIRCHILD'S PRODUCTS ARE NOT AUTHORIZED FOR USE AS CRITICAL COMPONENTS IN LIFE SUPPORT DEVICES OR SYSTEMS WITHOUT THE EXPRESS WRITTEN APPROVAL OF THE PRESIDENT OF FAIRCHILD SEMICONDUCTOR CORPORATION. As used herein:

1. Life support devices or systems are devices or systems which, (a) are intended for surgical implant into the body, or (b) support or sustain life, and (c) whose failure to perform when properly used in accordance with instructions for use provided in the labeling, can be reasonably expected to result in a significant injury of the user.
2. A critical component in any component of a life support device or system whose failure to perform can be reasonably expected to cause the failure of the life support device or system, or to affect its safety or effectiveness.