

▶ Hybrid stepper motors

6540-13

- Step angle 1.8°
- Size 42 x 42 mm
- Weight 200 g
- Holding torque 130/90 mNm

The hybrid stepper motor comes into its own where torque at low speed, positioning, and accuracy are determining factors.

▶ Technical data

	Part N°	Phase resistance [Ω]	Phase inductance [mH]	Phase current [A]	Holding torque [mNm]	Nominal power [W]
Bipolar	6540-13-2-2	2	2.7	1.12	130	5
	6540-13-2-9	9	13	0.52	130	5
	6540-13-2-36	36	37	0.26	130	5
Unipolar	6540-13-4-2	2	1.5	1.12	90	5
	6540-13-4-9	9	5.6	0.52	90	5
	6540-13-4-36	36	21	0.26	90	5

Steps/rev.	200
Step accuracy	± 5 %
Rotor inertia	18 gcm ²
Insulation class	B 130° C
Protection	DIN 40050 IP 30
Test voltage	500 VAC
Detent torque	10 mNm

▶ Dimensions

Drawing not to scale. All dimensions in mm.

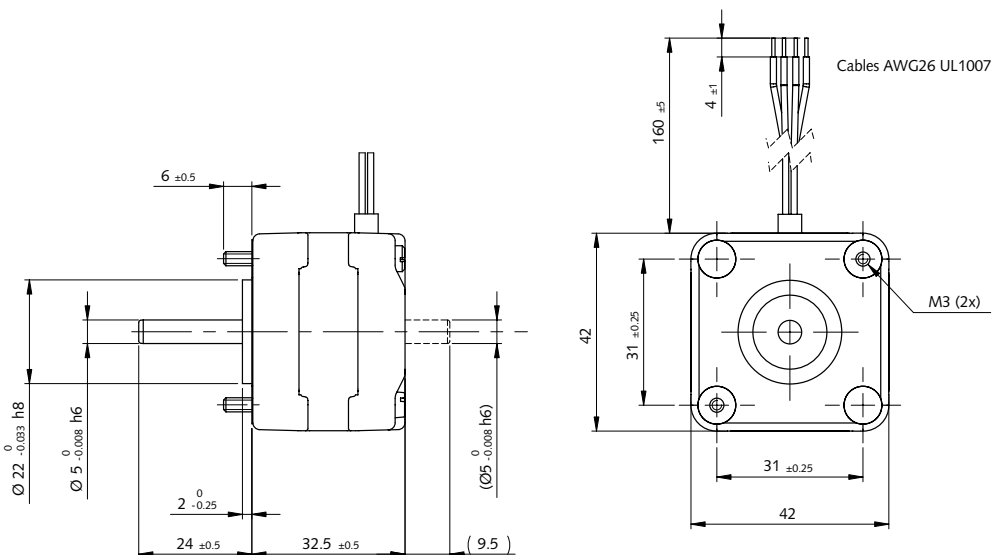

► Dynamic characteristics

• 6540-13-2-2

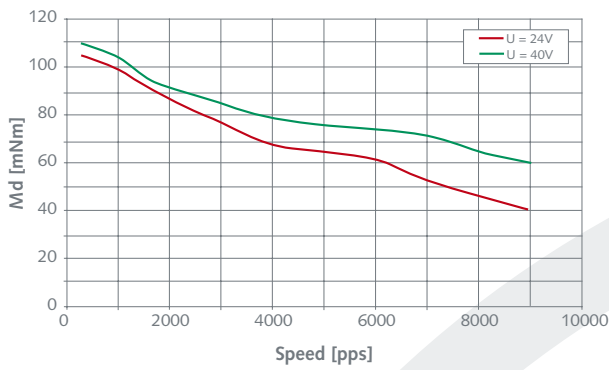

• 6540-13-2-9

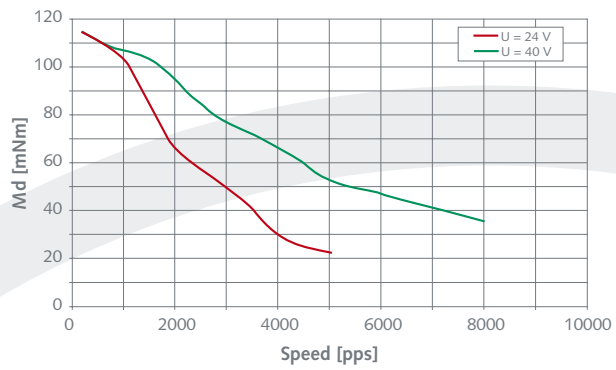

• 6540-13-2-36

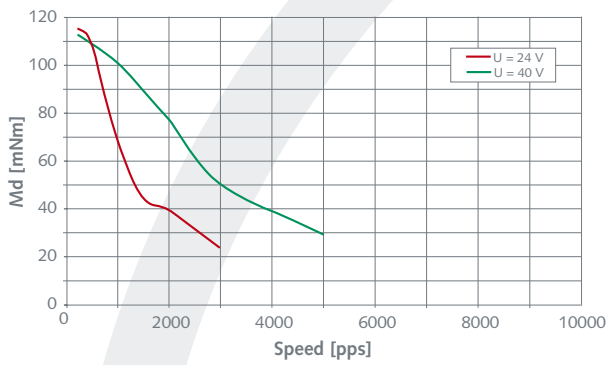

• 6540-13-4-2

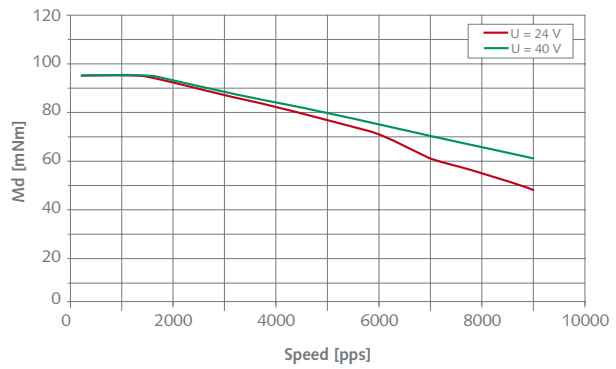

• 6540-13-4-9

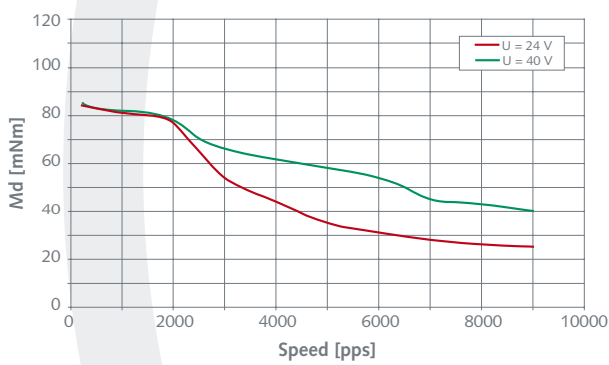

• 6540-13-4-36

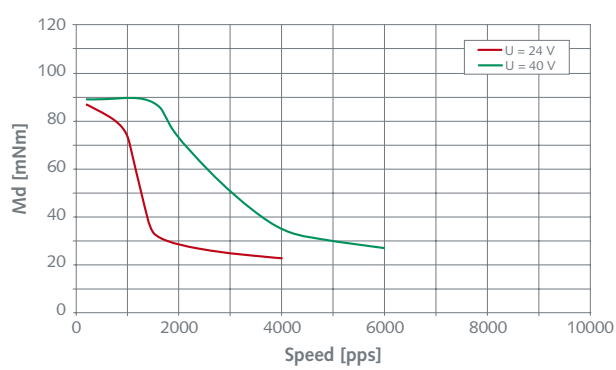

[pps] = pulses per second

Special requirements upon customer specifications. Right to change reserved.

< 1.0 >

▶ Static characteristics

• 6540-13-2 Series

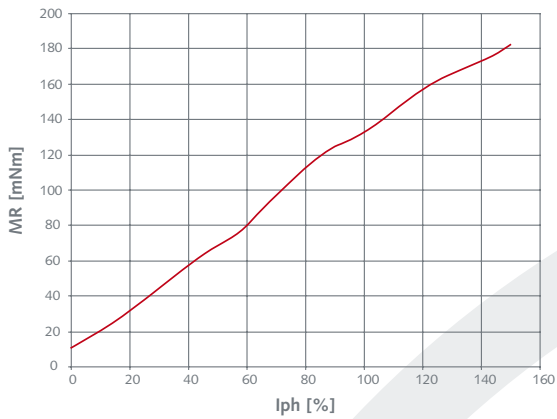

• 6540-13-4 Series

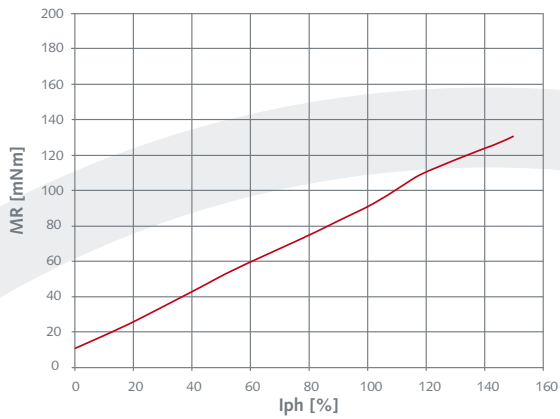

▶ Electrical Interface

• Bipolar

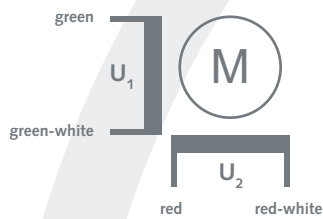

• Unipolar

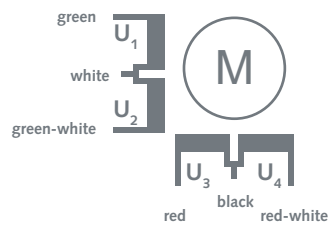

Special requirements upon customer specifications. Right to change reserved.

< 1.0 >