

Endstops (with optoisolation)

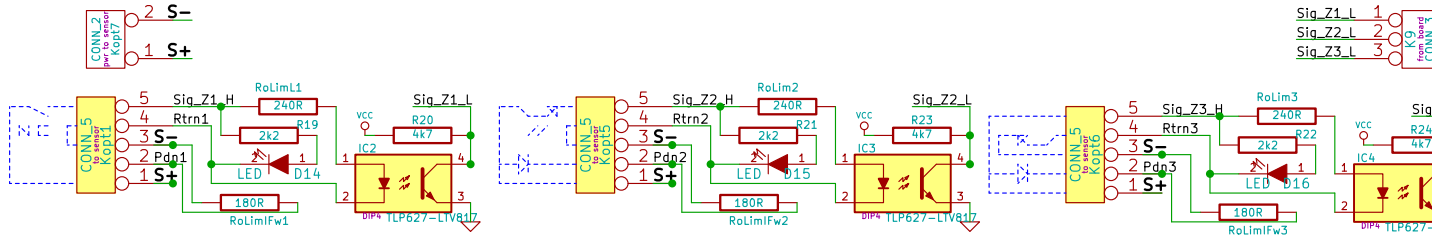

RoLim resistors to be adjusted for voltage used and current needed.

Endstops (with logic lvl)

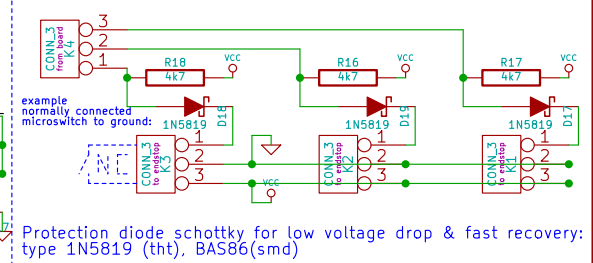

Protection diode schottky for low voltage drop & fast recovery: type 1N5819 (tht), BAS86(smd)

Thermistors

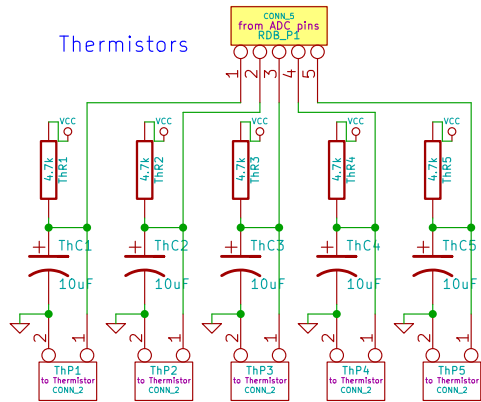

Power input

V.Regulator1: adj, board supply

V.Regulator2: adj, logic lvl

Power ends

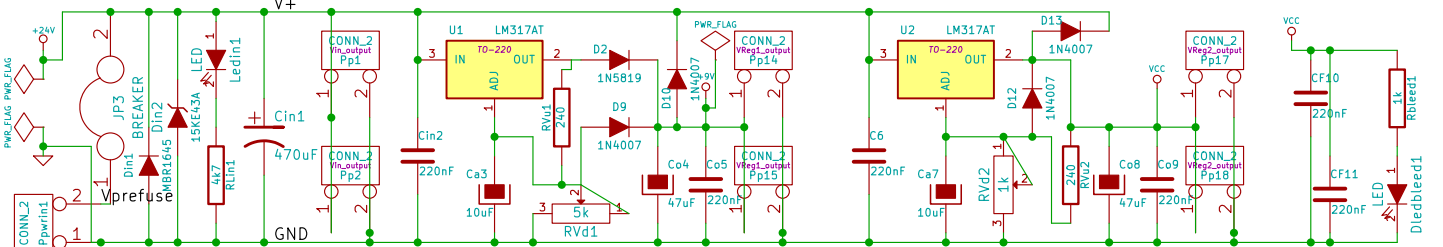

MBR or SPST diode current > fuse, Vbr min = Vin*1.3
 15KEA transil unidirectional Vbr min extra rating approx *1.2
 For 40-56V inputs use LM317HV, transil 15KE68A, SPST/MBR1660

Set Voltage Regulator 2 for logic level voltage.
 If development board has its own onboard regulator then match it.
 Most regulators 3pin, adj, TO220 are compatible (LM1086), but double check pinouts.

Low-side Hexfet Switches (Vdc)

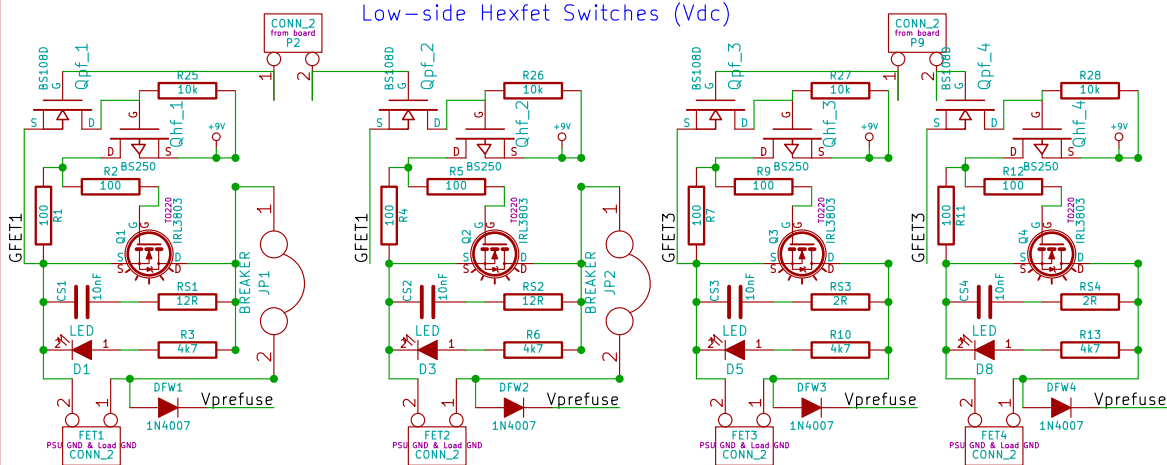

Attention: snubbers generic values; CS preferable high voltage; check RS power dissipation
 WARNING: these are low side switches.
 Connect fet Source pin to PSU GND directly, and the fet Drain pin to the line coming from load. Load needs V+ directly from psu.

Triac Switch (Vac)

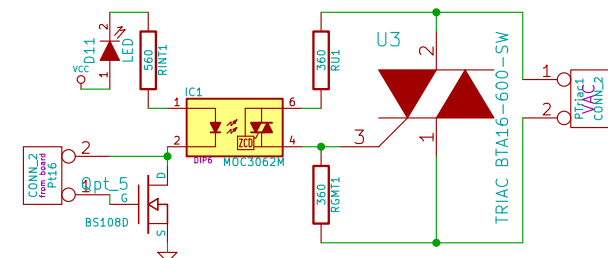

RINT = to give 5mA/moc3063, 10mA/moc3062 15mA/moc3061
 RU = 360R/moc306x
 RGMT = 360R/moc306x
 optional snubber default values RS=39R CS=10nF/1kV/disc

Holes

- X Hole1
- X Hole2
- X Hole3
- X Hole4
- X HoleRad1
- X HoleRad2
- X HoleRad3
- X HoleRad4

www.reprap.org/RDB

File: RDB_TS_001_G.sch

Sheet: /

Title: RDB_TS_001_G_DIY_ADJ

Size: A4

Date: 27 may 2013

Rev: 001alpha

KiCad E.D.A.

Id: 1/1